

Operating Instructions

Diplomat Tripod Screen by Draper

Caution

- ① Read instructions through completely before proceeding, and save for future reference.
- ② Nothing should be fastened to screen case or viewing surface.
- ③ Do not write on viewing surface.

NOTE: Screen has been thoroughly inspected and tested at factory and found to be operating properly prior to shipment.

Setting Up the Screen

- ① Grasp the main stem of the tripod with your right hand just above the handle. Pull out plunger (A) slightly with your left hand, lift screen and push down gently on the plunger. Legs will slide open.
- ② Pull out plunger (B) slightly and slide the extension tube up to the first stop, where plunger (B) will automatically engage.
- ③ Rotate screen to horizontal position.
- ④ If you want to use the built-in keystone eliminator, pull it out of the gooseneck and swing it to horizontal.
- ⑤ Pull the screen out of the case and hook the handle on the the dowel over the gooseneck (or keystone eliminator).
- ⑥ If you want to move the case up or down the stem, grasp the handle and gently squeeze the two triggers (C) and (D) together. This allows the handle to slide freely up and down the stem. When you release the triggers the handle will lock in place automatically.
- ⑦ Pull out plunger (B) slightly and move the extension tube until screen is extended to desired height.

NOTE: Viewing surface may be tensioned by moving the case down slightly on the stem.

Using Keystone Eliminator

- ① If image is narrower at the top, use keystone eliminator to bring top of viewing surface toward the projector.
- ② If image is narrower at the bottom, make sure keystone eliminator is all the way back and use projector adjustment to correct.

Taking Down the Screen

- ① Grasp the extension tube firmly with your left hand and pull plunger (B) out gently with your right hand. Guide extension tube down until it reaches the next to the lowest stop.
- ② Return tripod handle to its original position by squeezing the two triggers together and sliding the handle on the stem until trigger (C) snaps into the hole on the main stem.
- ③ Remove screen from gooseneck (or keystone eliminator) and allow screen to retract **gently** into the case.
- ④ Slide keystone eliminator back inside the gooseneck.
- ⑤ Return case to vertical position and lower extension tube until the gooseneck drops into the hole in the end cap of the screen case.
- ⑥ Grasp the main stem just above the handle and lift the screen off the floor. Pull up on the leg bracket until legs fold up completely.
- ⑦ Place the screen on the floor and press down on the main stem until plunger (A) snaps into place, locking the legs to the **Bell Leg Lock**.

Collapsed Screen

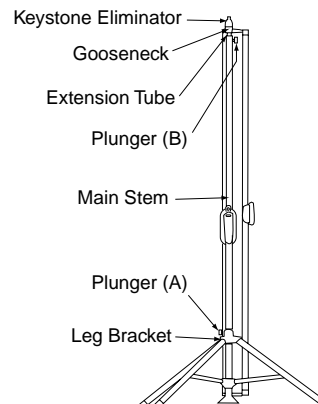

Open Screen

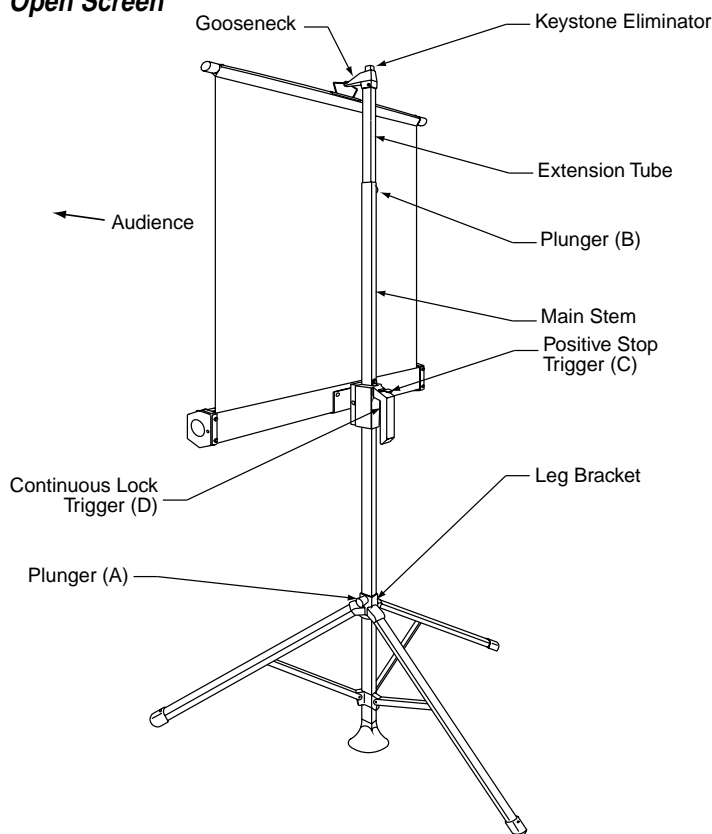

Keystone Eliminator

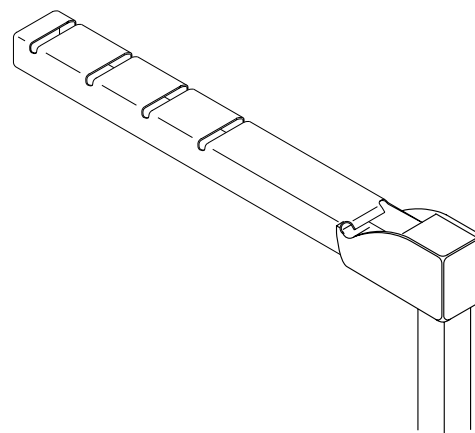

DRAPER

411 S. Pearl St., Spiceland, IN 47385 USA ■ 765-987-7999 ■ fax 765-987-7142
 e-mail draper@draperinc.com ■ www.draperinc.com

Copyright © 2002 Draper Inc.

Form Diplomat_Inst02

Printed in U.S.A.